

CRISTALEIRA AREZZO

INSTRUÇÃO DE MONTAGEM

1ª MONTAGEM

ENCAIXE A BUCHA (R) E O NIVELADOR (K) NA BASE (1). FIXAR AS LATERAIS (4) COM PARAFUSO (Q).

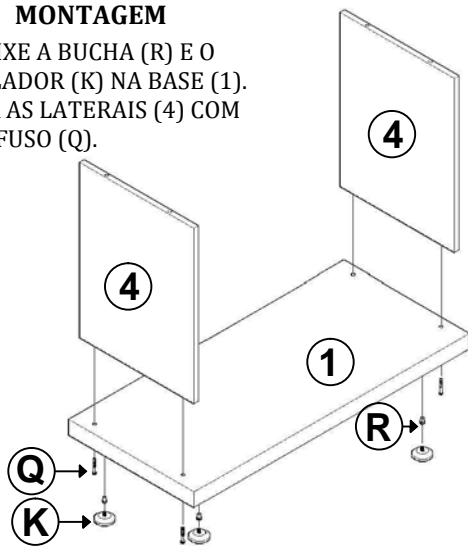

2ª MONTAGEM

FIXAR O PONTALETE (10) NO PONTALETE (9) COM PINO (M) E TAMBOR (N).

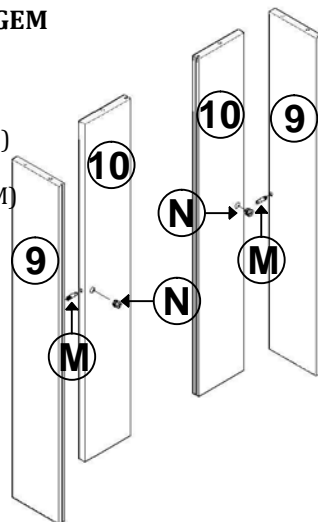

3ª MONTAGEM

FIXAR OS ESPELHOS (11) ENTRE OS PONTALETES (10). ENCAIXE OS VIDROS (13) NOS PONTALETES (9), E FIXE TODOS OS PONTALETES NA BASE CENTRAL (2) COM PARAFUSO (O) E CAVILHA (L). E O VIDRO (13) NO SUPORTE (F).

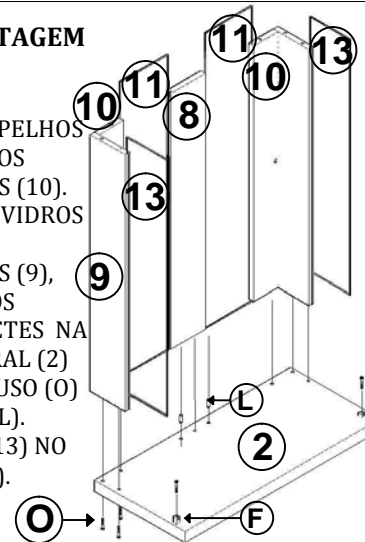

4ª MONTAGEM

FIXAR A BASE SUPERIOR (3) NA ESTRUTURA DOS PONTALETES COM PARAFUSO (Q) E CAVILHA (L) NO CENTRAL.

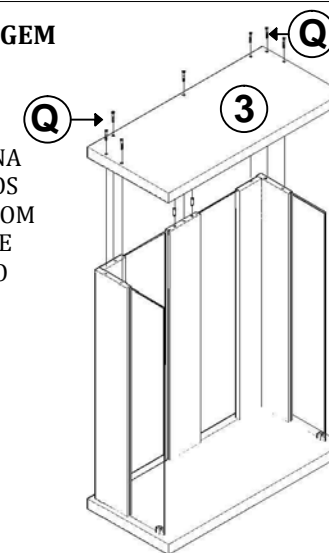

5ª MONTAGEM

FIXE OS APLIQUE (6) E (7) COM MINIFIX (M) E (N). FIXAR A ESTRUTURA DA (1ª MONTAGEM) JUNTO A (2ª MONTAGEM) COM CAVILHA (L) E MINIFIX (M) E (N).

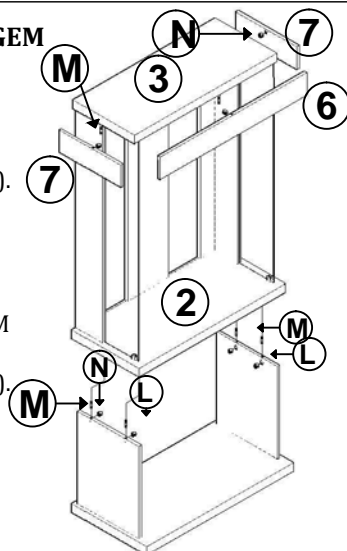

6ª MONTAGEM

FIXAR A PORTA (5) COM DOBRADIÇA (H) E PARAFUSO (I). COLOCAR O FUNDO (12) COM PREGO (P) E PERFIL (G).

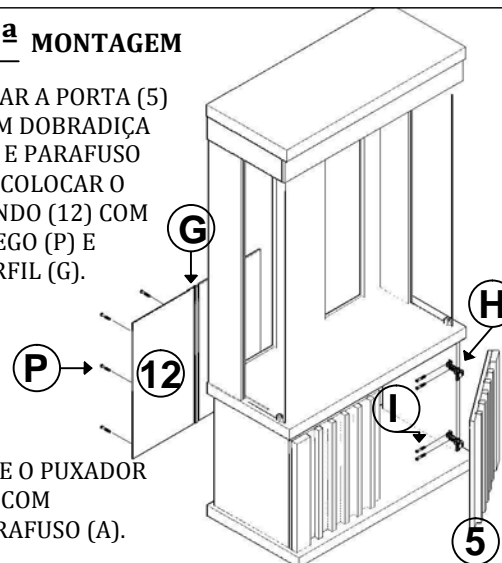

FIXE O PUXADOR (C) COM PARAFUSO (A).

7ª MONTAGEM

FIXE OS SUPORTE (F) NA MARCAÇÃO DOS PONTALETES E COLOQUE OS VIDOS (15).

FIXAR O BATENTE EM L (T) NA BASE CENTRAL PARA, ENCOSTAR A PORTA

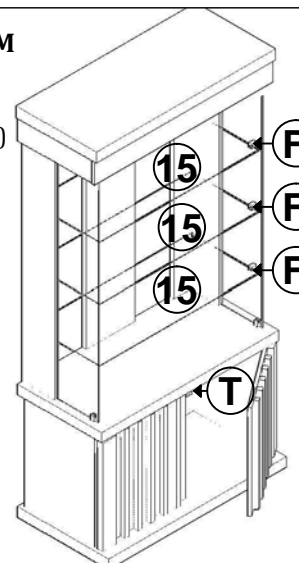

8ª MONTAGEM

FIXAR A PORTA (14) COM A DOBRADIÇA DE VIDRO (E). E O PUXADOR (C) COM PARAFUSO (A).

FIXAR O BATENTE RETO (S) NO APLIQUE GRANDE, PARA ENCOSTAR A PORTA DE VIDRO.

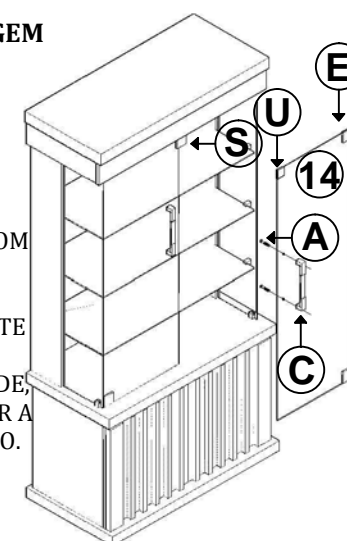

A- Parafuso 4,0x16 panela (04 PÇS)  (Para puxador Decor)

B- Parafuso 3,5x25 chato (02 PÇS)  (Fixar na peça nº 7)

C- Puxador Decor (02 PÇS) 

D- Chave Zeta (01 PÇS) 

E- Dobradiça para porta de vidro (04PÇS) 

F- Suporte de jacaré (14 PÇS) 

G- Perfil H (01 PÇS) 

H- Dobradiça 35mm reto c/ calço(04 PÇS) 

I- Parafuso 3,5 x 14 (37 PÇ) 

J- Arruela silicone p/ vidro (04 PÇS) 

K- Sapata niveladora 1/4 (04 PÇS) 

L-Cavilha 8 x 30 (12 PÇS) 

M- Pino minifix (09 PÇS) 

N-Tambor de minifix (09 PÇS) 

O- Parafuso 7,0 x 50 chato escareado allen (05 PÇ) 

P-Prego 10 x 10 (16 PÇS) 

Q- Parafuso 7,0 x 70 TP 13 allen (09 PÇS) 

R- Bucha plástica 1/4 (04 PÇS) 

S- Parada plástico reto c/ imã 4 x 4(01 pç) 

T- Parada plástico em L (02 pç) 

U- Chapa U metalica c/ adesivo p/ porta de vidro (02 pçs) 

Relação de Peças

- 1- BASE INFERIOR (01PÇ)
- 2- BASE CENTRAL (01 PÇ)
- 3- BASE SUPERIOR (01PÇ)
- 4- LATERAL INFERIOR (02 PÇS)
- 5- PORTA (02 PÇS)
- 6- APLIQUE GRANDE (01 PÇ)
- 7- APLIQUE PEQUENO (02 PÇS)
- 8- PONTALETE CENTRAL (01 PÇ)
- 9- PONTALETE LATERAL (02 PÇS)
- 10- PONTALETE LAT.DO FUNDO (02 PÇ)
- 11- ESPELHO (02 PÇS)
- 12- FUNDO DA CRISTALEIRA (02 PÇS)
- 13- LATERAL DE VIDRO (02 PÇS)
- 14- PORTA DE VIDRO (02 PÇS)
- 15- PRATELEIRA DE VIDRO (03 PÇS)